

5'H X 4'W STRONGHOLD IRON WALK GATE  
SIGNATURE GRADE - STYLE #1: CLASSIC

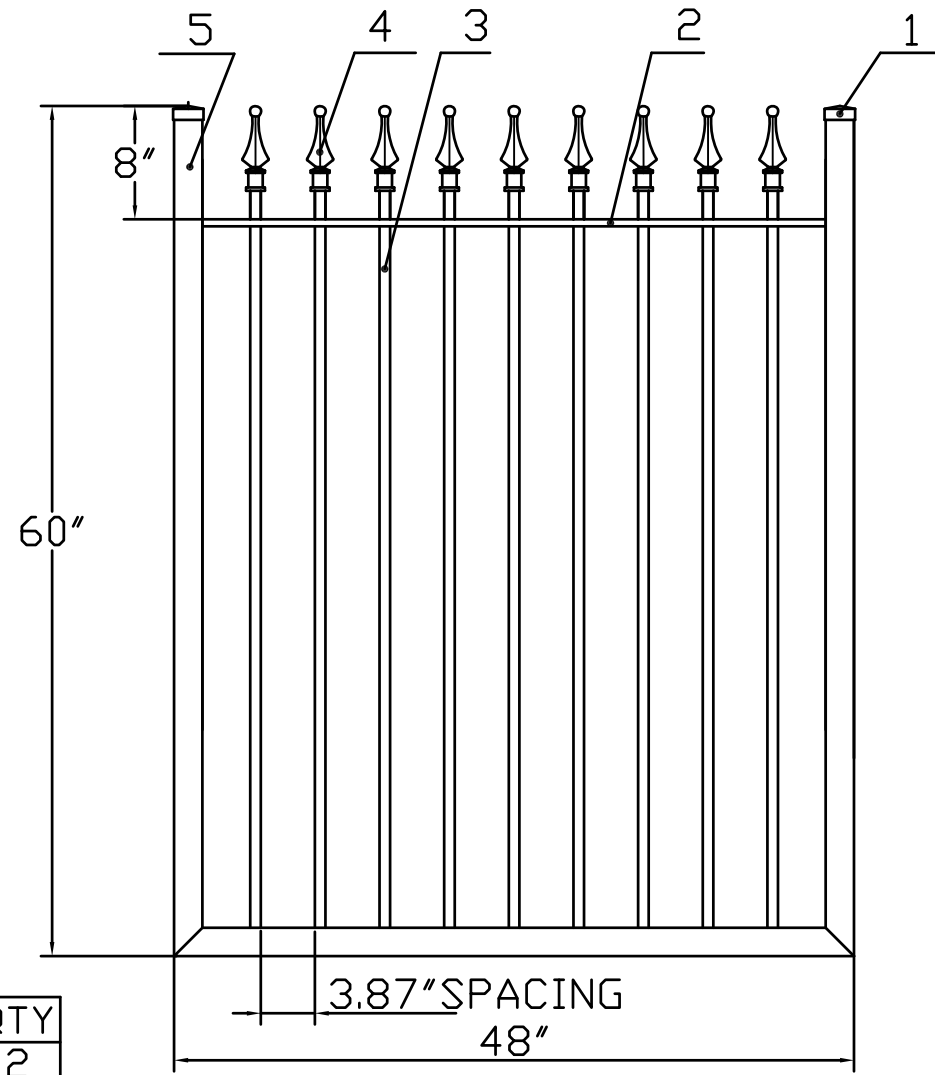

www.ironfenceshop.com  
(800) 261-2729



NO.	MATERIAL	QTY
1	CAST IRON CAP	2
2	┌ 1 1/2"X1/2"X1/8"	1
3	3/4"X3/4"X16ga	9
4	CAST IRON FINIAL	9
5	2"X2"X14ga	3

TP0504-CG